

多功能漂染洗

高效 节能 环保 智能

High Efficiency Energy Saving Environmental Protection Intelligence

月发——成就客户利润的最大化

TruWash™

针梭两用智能型高效绳状水洗衣机
High Intelligent Efficiency Overflow Machine



前后道处理方案供应商
Bleaching & Washing processing solution

江阴月发印染机械有限公司
REFA TEXTILE MACHINERY CO., LTD

地址：江苏省江阴市青阳镇工业园桐安路 153 号
NO.153, TongAn Road, Jiang Yin City, Jiang Su Province, China

总机 (TEL): +86 0510 86596765

手机 (MOB): +86 13812115508

网站 (WEB): WWW.REFATECH.CN

Global: +86 18115380550

E-mail: klein@fafatech.cn

江阴月发印染机械有限公司
REFA TEXTILE MACHINERY CO., LTD

公司简介

江阴月发印染机械有限公司地处美丽富饶的长江三角洲中心的百强县江阴市青阳镇工业区，是集产品研发、设计、生产、安装于一体的印染机械专业制造商。

REFA Textile Machinery Co., Ltd. is a professional manufacturer of printing and dyeing machinery integrating product development, design, production and installation.

经过多年的努力发展，公司已经持有 10 多项应用型专利并且形成了空柔整理、平幅针织染整、绳状水洗等三大板块，其中包含平幅气流柔软机、多功能高效绳状水洗机、针织平幅连续煮漂机、针织平幅冷染机、针织平幅印花后水洗机、平幅短流程丝光机、针织平幅冷轧堆前处理、除油预缩水洗机、染色后水洗机、彩条麻灰水洗机等产品。

After decades of development, the company has formed three major sections:

- I .Air-soft finishing,
- II .Open-width knitting CPB/CP-dyeing/Bleaching/Washing after dyeing or printing short range mercerizing, knitted open-width cold-rolling pre-treatment, degreasing and pre-shrinking washing machine, post-dyeing washing machine, color strip ash washing Machine and other products.
- III . Modular overflow rope washing (multi-functional and efficient)

公司秉承“创新为本、信誉为重、质量为先”的理念，整合外部资源，优化内部管理，不断开拓创新，朝着业务专业化、经营多元化的方向阔步前进，在节能减排即是提升产能的大环境下为广大客户引领行业转型升级提供环保、节能、高产的优质产品和完善的售后服务。

The company adheres to the concept of "innovation-oriented, reputation-oriented, and quality-first", integrates external resources, optimizes internal management, continues to innovate, and makes strides towards professionalization of business and diversification of operations. Under the environment of increasing production capacity, we will provide our customers with environmentally friendly, energy-saving, high-yield quality products and perfect after-sales service to lead the transformation and upgrading of the industry.

荣获多项国家专利

Multiple patents

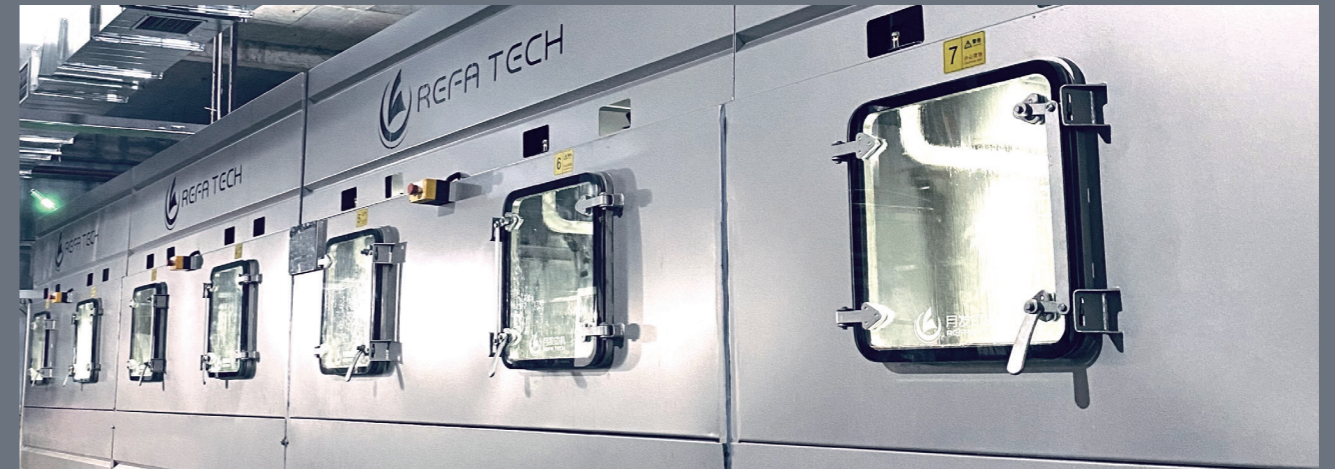
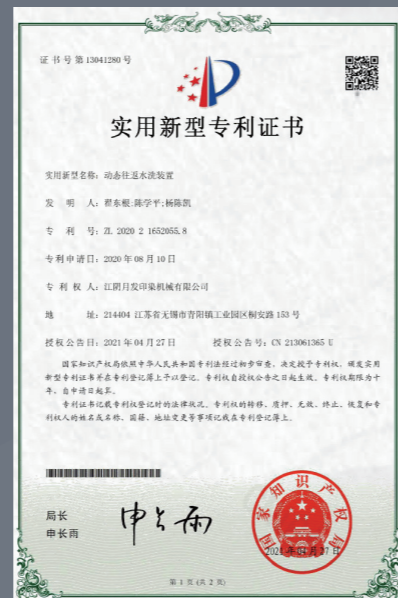
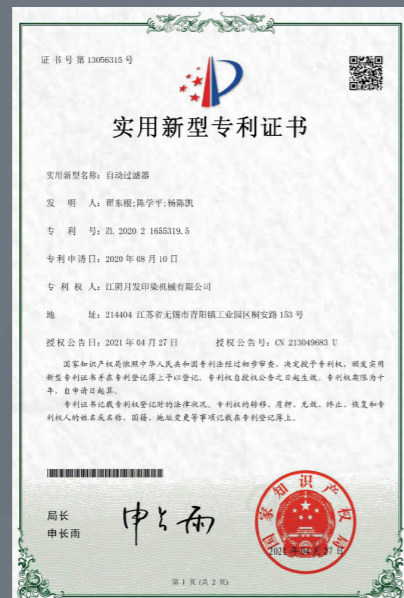
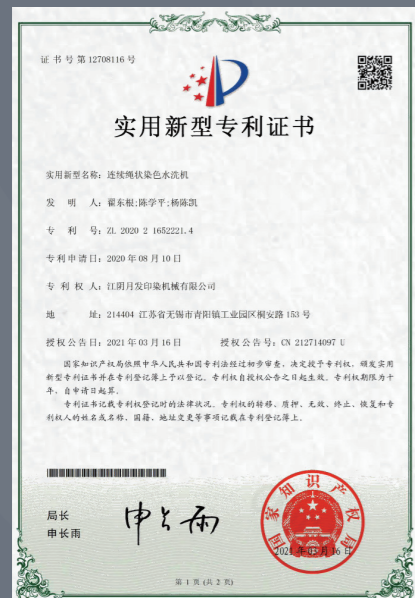

正侧方视角
45° angle



电柜
Electric cabinet



加热细节
Heating details



内部细节
Inside details



导布管
Guiding tube



侧后方视角
Rear side view



喷嘴细节
Nozzle details

※ 主要特征 Main features

- 1、整机占地面积小
- 2、浸料充分，汽蒸透彻
- 3、往返水洗、洗透力强
- 4、水、电、汽的耗能低
- 5、自动化程度高，用工少
- 6、适用性广，各种面料的多种工艺
- 7、确保面料运行过程中不堵布、不拉空

荧光增白 / 酶洗 / 碱减量水洗 (YFS-T12 型)

Brightening/alkali decrement/Enzyme washing(YFS-T12)

装机功率 (Power) : 43KW

外形尺寸: 10500 × 3220 × 2800mm (长 × 宽 × 高) (Length X Width x Height)

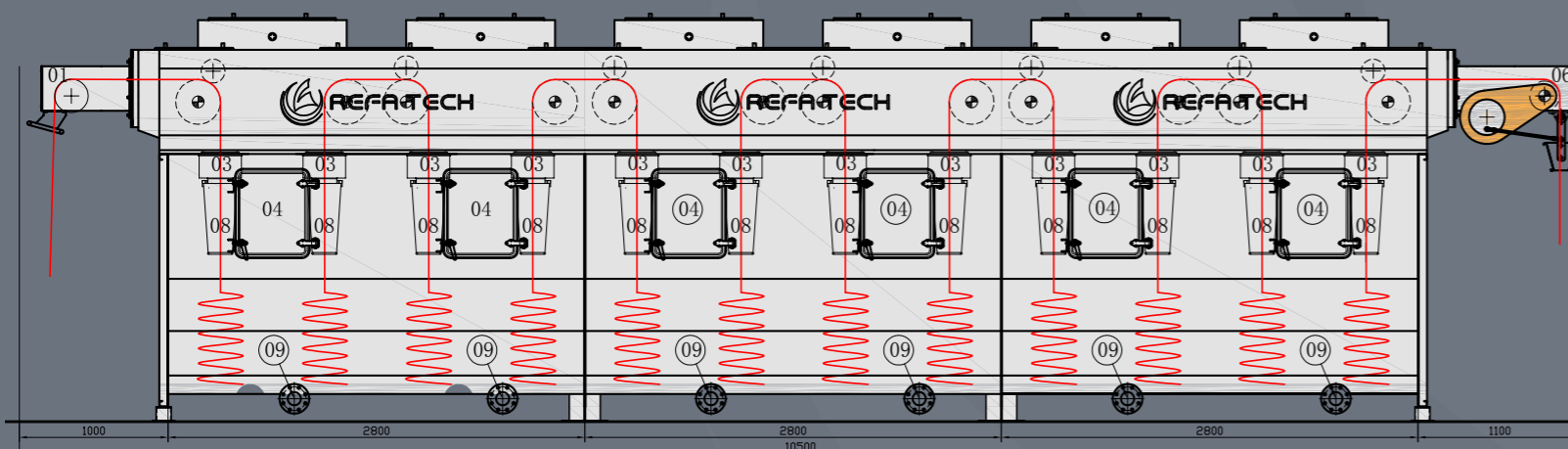

※ 工作原理 Working principle

月发 - 全新一代高效绳状水洗机: 为多个模块组合而成, 每个模块有 2 个单元, 每单元为相邻的 2 槽通过提布轮和喷嘴的配合, 来回、往返冲洗的过程。

RefaTech the whole new generation continuous rope type overflow washing machine: Each module consists of two unit, each unit has 2 adjacent chambers, lift rollers and nozzle to achieve the back and forth washing process.

※ 工艺效果 Process effect

- | | | |
|-------------------------------------|-------------------------------------|--|
| ● 连续煮炼漂白
Continuous bleaching | ● 连续染色后水洗
Washing after dyeing | ● 化纤及色织布退浆
Desizing |
| ● 连续酶洗蚀毛
Continuous enzyme | ● 连续印花后水洗
Washing after printing | ● 丝光后中和水洗
Neutralize wash after mercerization |
| ● 连续荧光增白
Fluorescent brightening | ● 连续碱减量水洗
Alkali decrement | ● 冷堆后连续煮漂
CP continuous bleaching |

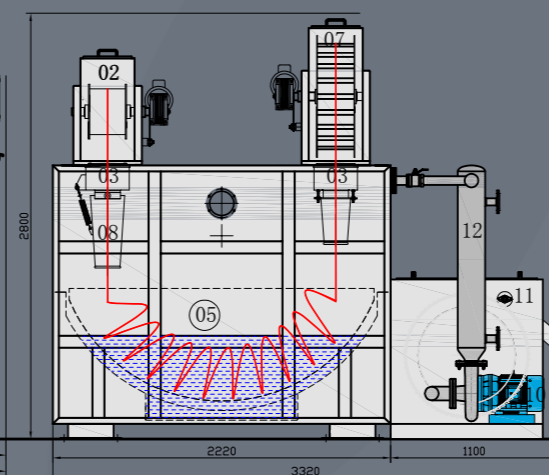

面料在水洗槽内往返运动, 可以获得更长的皂煮时间和更多的冲洗次数。

面料每分钟来回通过 4 个喷嘴往返运行, 并使面料不断的进行逆行冲洗和顺行冲洗。布面通过与水的不间断切换, 从而达到高效、强烈、充分的洗涤效果。

Fabric in chamber back and forth movement, can be obtained Longer soap cooking time and more rinsing times. The fabric goes back and forth through 4 nozzles per unit every minute, and make the surface through with water uninterrupted Switch, so as to achieve efficient, intense, full Washing effect.

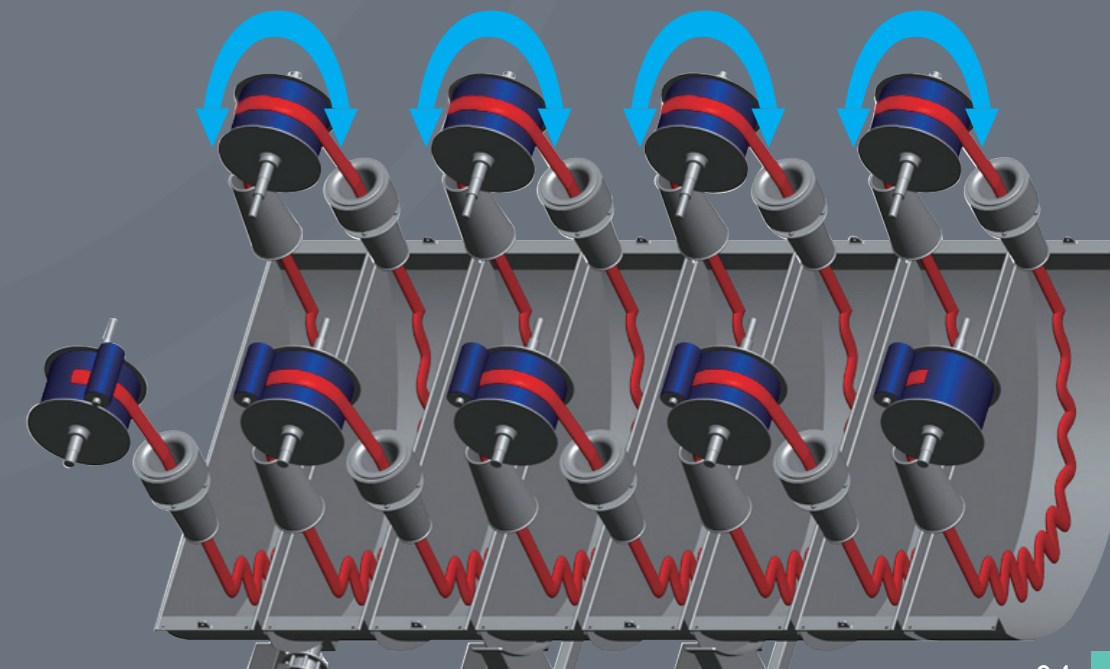
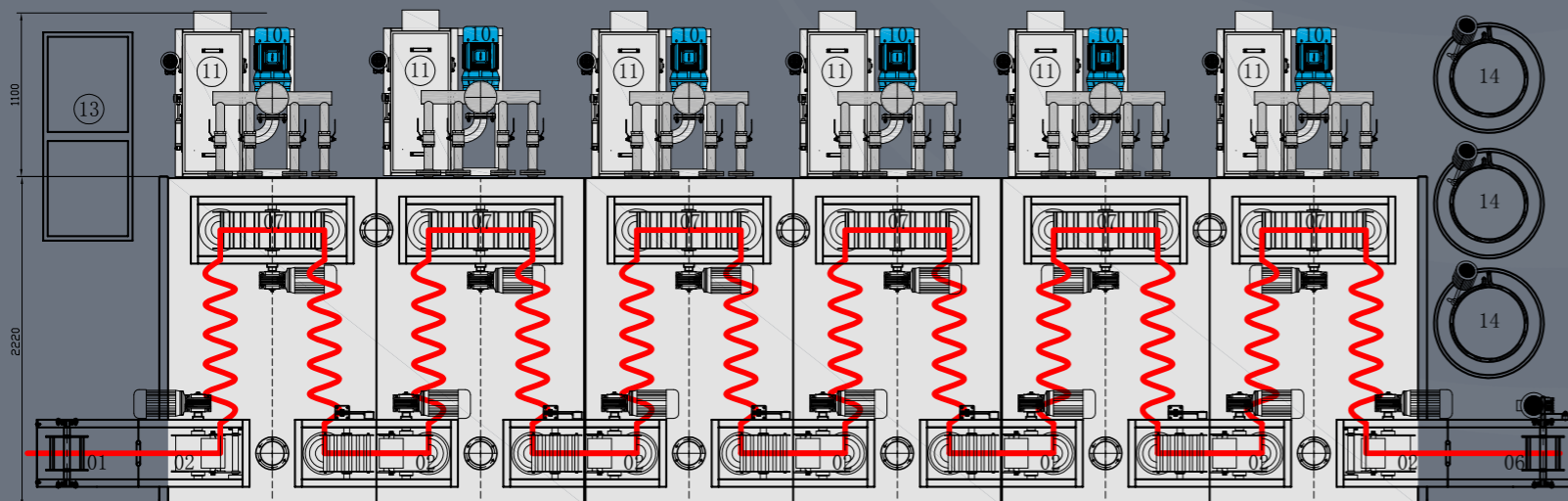

● 连续绳状辊床煮炼漂白机 Rope type roller bed bleaching

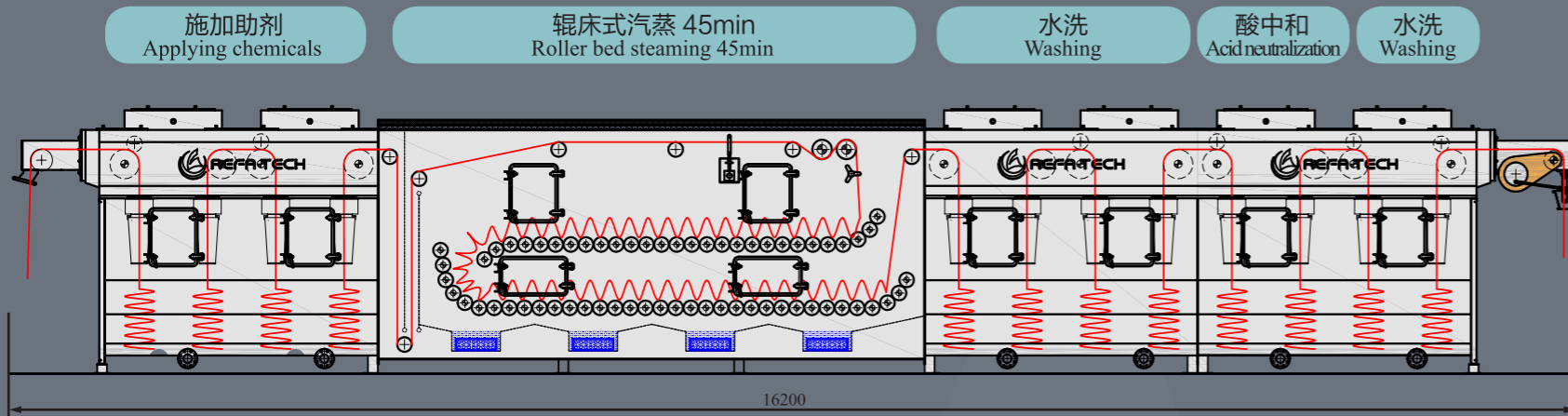

● 连续平幅辊床 + 绳状煮炼漂白机 Open width roller bed + Rope type bleaching

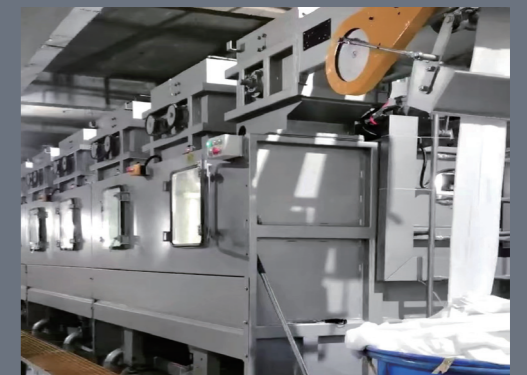
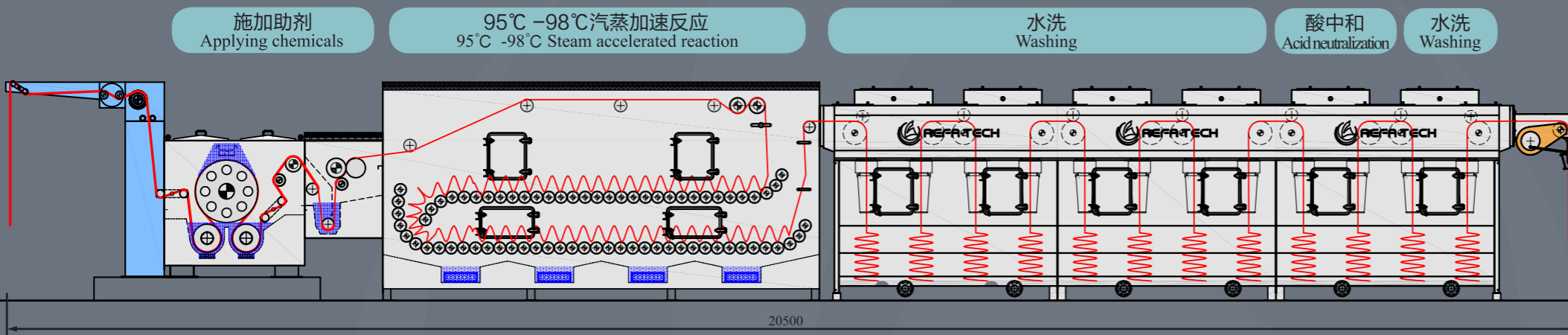

● 连续平幅冷堆 + 绳状煮炼漂白机 CPB+Rope type bleaching

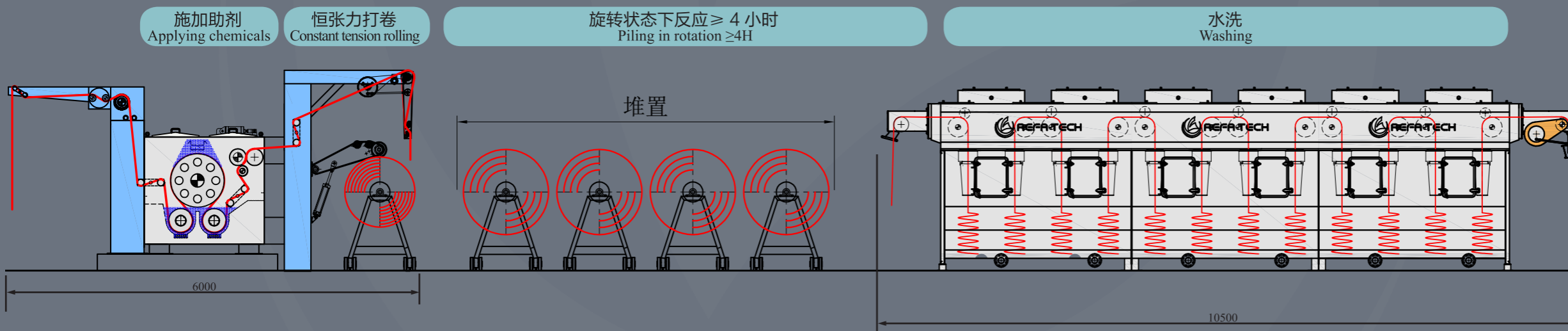

※ 连续煮炼漂白机能耗

- 耗水量: 6-8吨/吨·布
- 耗蒸汽量: 0.6-0.8吨/吨·布
- 耗电量: 45度/小时
- 产量: 16-18吨/22小时

※ Consumption

- Water: 6-8T/T·Cloth
- Steam: 0.6-0.8T/T·Cloth
- Power: 45KW/H
- Production: 16-18T/22H

● 染色后水洗 (YFS-T16 型)

Washing after dyeing(YFS-T16)

外形尺寸: 13300 × 3220 × 2800mm (长 × 宽 × 高) (Length X Width x Height)

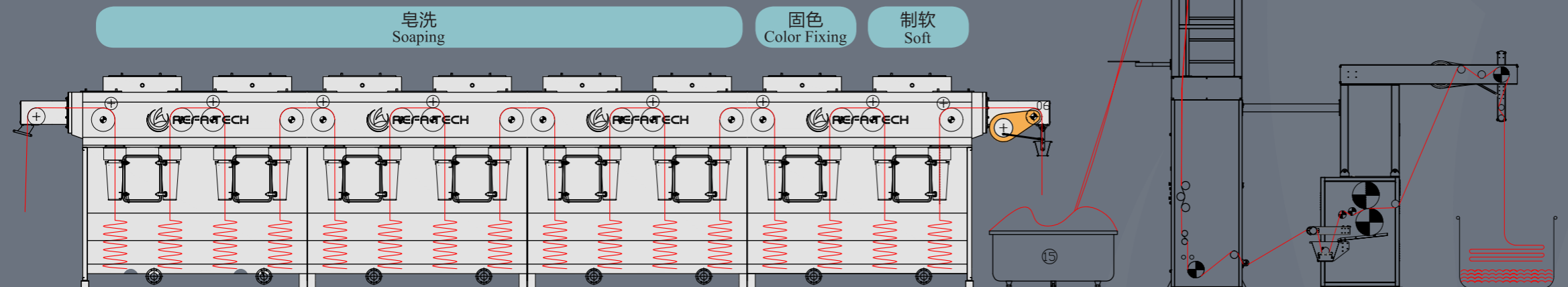

染色: 耗水量 5-6 吨 / 吨 · 布 装机功率 56KW 产能: 15 吨左右 / 天
 Staining: Water: 5-6Ton/ton cloth Power: 56KW Yield: 15Tons/day or so

以纯棉针织大黑 4+ 色牢度为例，在染缸中至少需要 7-8 缸水来完成，以 1:5 的浴比来计算也需要 40 吨的水，按照 17 块 / 吨水处理费计算，水成本在 680 元 / 吨布。TruWash 根据实际客户生产耗水数据为 5 吨 / 吨布，水成本在 85 元 / 吨布，相差 595 元，按 500 吨 / 月，全年 6000 吨的产量，一台 TruWash 可以节约 357,0000 元合计 357 万人民币，这还仅仅是耗水成本这一块。

Taking the deep black of 100% cotton knitting as an example, it needs at least 7-8 tanks of water to get 4+ color fastness in the dyeing machine.

Dyeing machine With a liquor ratio of 1:5, 40 tons of water is needed at least, based on 17yuan/ton of water treatment fee, The water cost is 680 yuan/ton of cloth.

TruWash™ based on actual customers' production is 5 tons/ton of cloth. The water cost is 85 yuan/ton cloth, comparing with dyeing machine reduced by 595 yuan/ton, according to 500 tons/month, 6000 tons a year, A TruWash™ can save 3.57 million yuan in total, and that's only the water costs.

	对比项目	月发印机	传统染缸
耗 能	耗水量	5-6 吨 / 吨布	40-50 吨 / 吨布
	耗电量	35 度 / 吨布	124 度 / 吨布
	耗蒸汽量	0.6 吨 / 吨布	2.68 吨 / 吨布
工 艺	色牢度	3.5-4 级以上	3 级左右
	产量 (深色)	15 吨左右	视染缸个数
	耗时	用时短	用时长
	布面清洁度	无毛羽	比较脏
	工艺重现性	重现好	有缸差

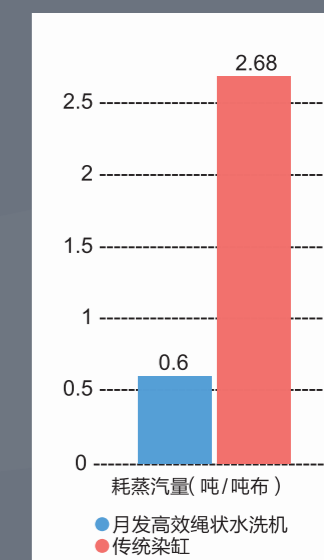
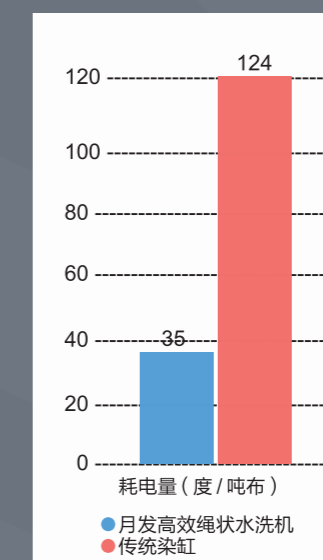
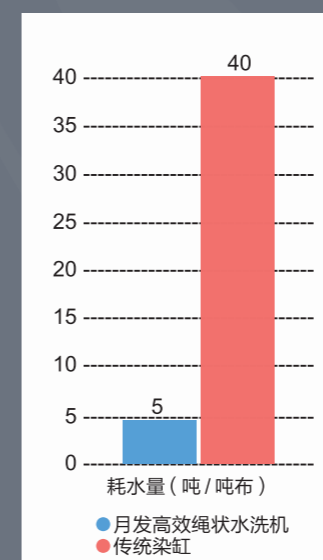

● YFS-T16 型印花后高效水洗机

YFS-T16 Printing washing machine

外形尺寸: 13300 × 3220 × 2800mm (长 × 宽 × 高) (Length X Width x Height)

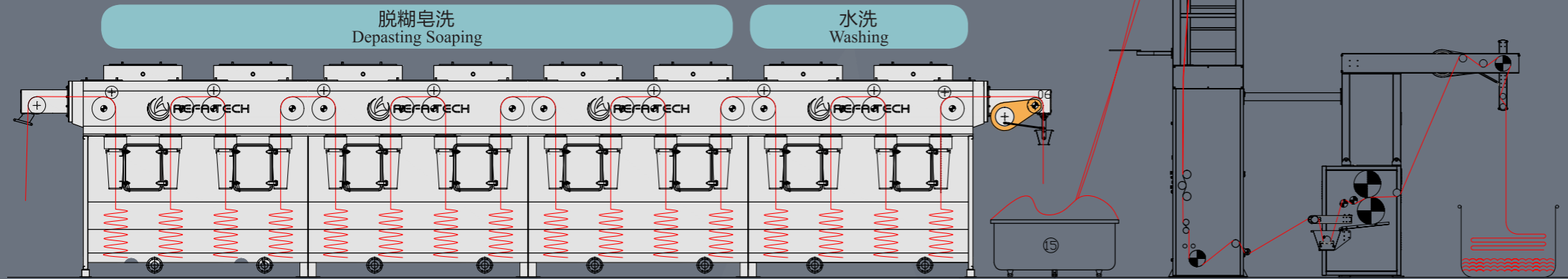

● YFS-PT16 型印花后高效水洗机

YFS-PT16 Printing washing machine

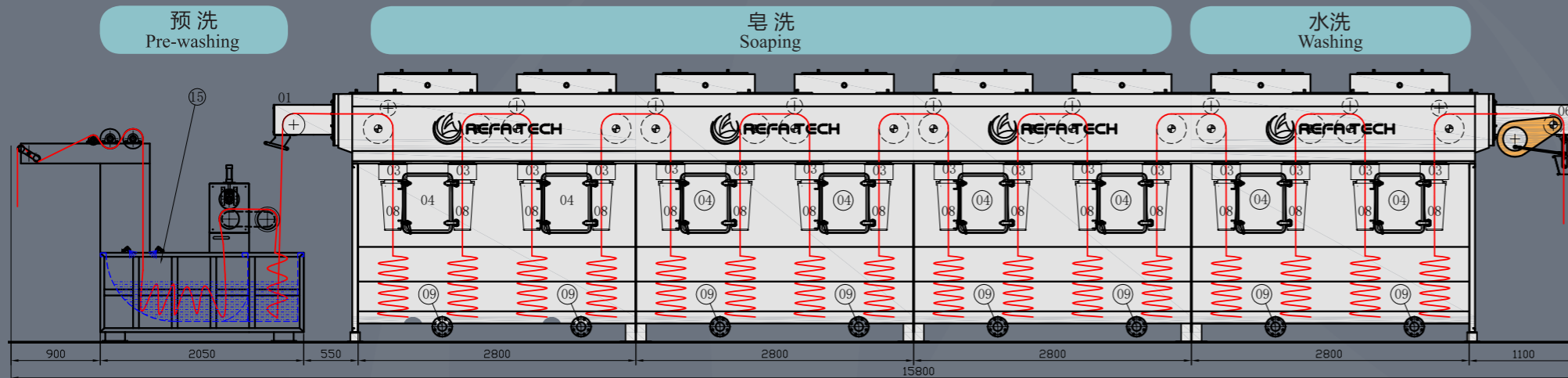

※ 印花后水洗能耗

- 耗水量: 6-12 吨 / 吨 · 布 (视深浅色)
- 耗蒸汽量: 0.7-0.9 吨 / 吨 · 布
- 耗电量: 35 度 / 小时
- 产量: 15 吨左右 / 22 小时

※ Consumption

- Water: 6-12T/T·Cloth
- Steam: 0.7-0.9T/T·Cloth
- Power: 35KW/H
- Production: 15T/22H

● YFS-P2T12 型印花后高效水洗机

YFS-P2T12 Printing washing machine

